

PLANTA BAIXA DEMOLIR/ CONSTRUIR
ESC. 1/50

PREFEITURA MUNICIPAL DE SOORETAMA PROJETO DE REFORMA ABRIGO MUNICIPAL		
	ENDEREÇO: RUA CAIA MIRIM BAIRRO CAMARÁ - SOORETAMA - ES	PRANCHA: 01/01
	 JISLANA BOBBIO Data: 22/11/2023 09:31:27 -0300 Verifique em https://portal.tri.gov.br	
DESENHO: JISLANA BOBBIO		DATA: JULHO/2023 OBS:

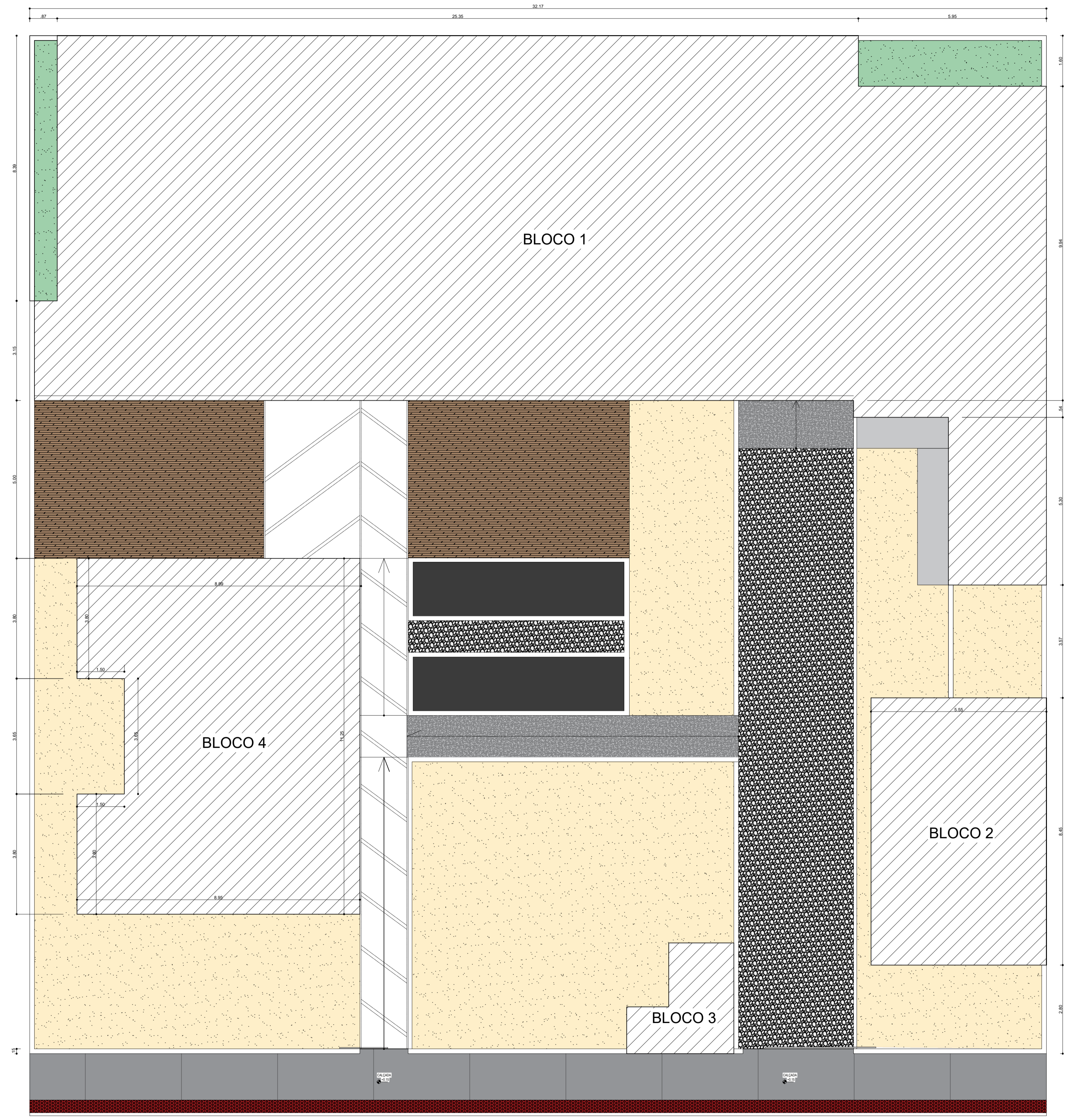

IMPLANTAÇÃO
esc 1:75

NSA
esc 1:200

PREFEITURA MUNICIPAL DE SOORETAMA PROJETO DE REFORMA ABRIGO MUNICIPAL		
	ENDEREÇO: RUA CAJAMON, 500 - SOORETAMA - ES	PRANCHA: 01/05
	DESIGNADO: JISLANIA BOBBIO Data: 22/11/2023 09:31:27-0300 Verifique em https://webstar.dl.gov.br	DATA: JULHO/2023
	DESENHO: JISLANIA BOBBIO	OBS:



PLANTA BAIXA LAYOUT
esc 1:75

PREFEITURA MUNICIPAL DE SOORETAMA PROJETO DE REFORMA ABRIGO MUNICIPAL		
	ENDEREÇO: RUA CAIAPIRANGA, 100 - SOORETAMA - ES 	PRANCHA: 02/05
	DESENHO: JISLANIA BOBBIO	DATA: JULHO/2023 OBS:

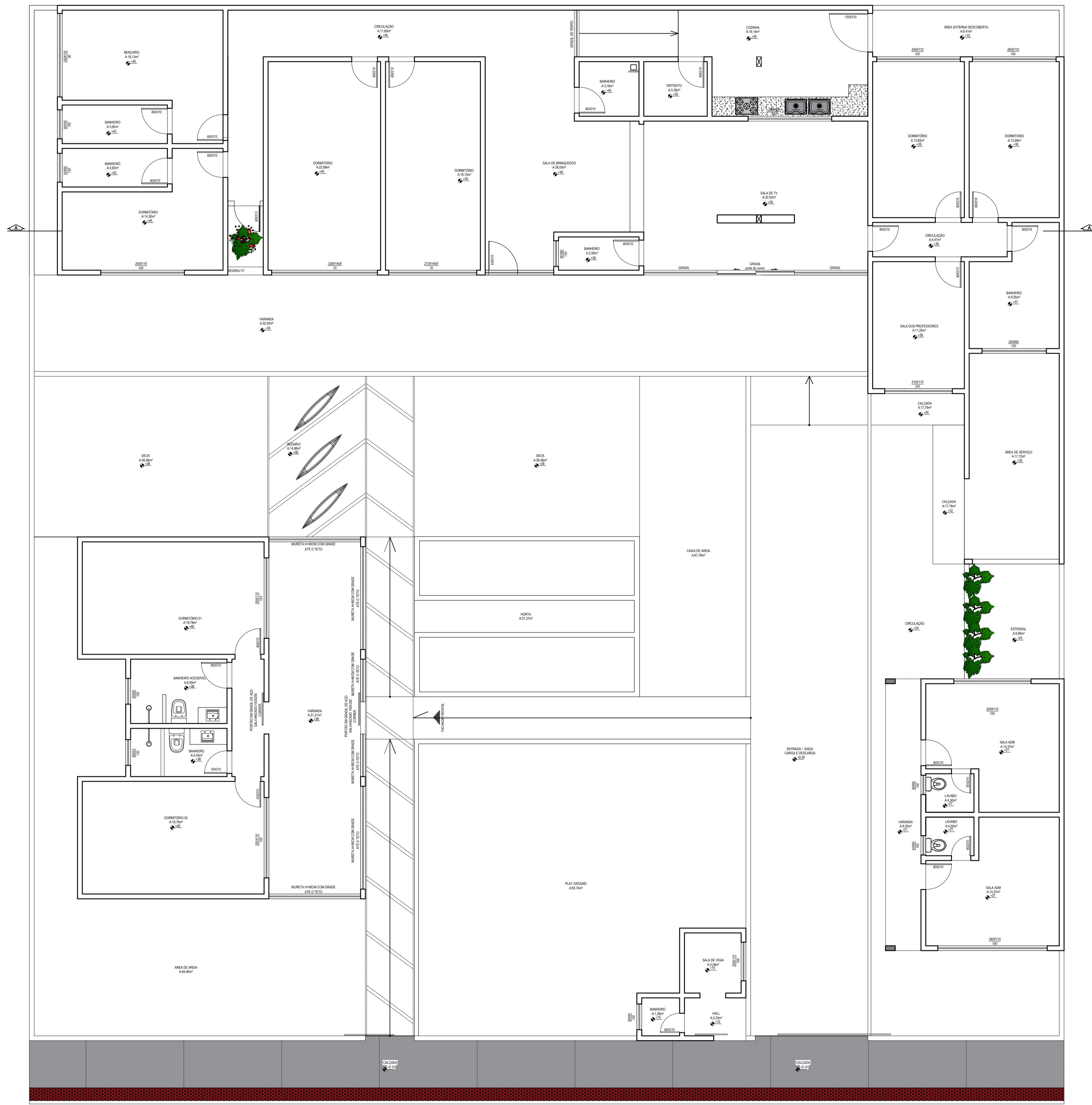

PLANTA BAIXA TOTAL
esc. 1:75

PREFEITURA MUNICIPAL DE SOORETAMA PROJETO DE REFORMA ABRIGO MUNICIPAL		
	ENDEREÇO: RUA CAJA MIRIM, BAIRRO CANAÃ - SOORETAMA - ES 	PRANCHA: 03/05
	DESENHO: JISLÂNIA BOBBIO	DATA: JULHO/2023 OBS:

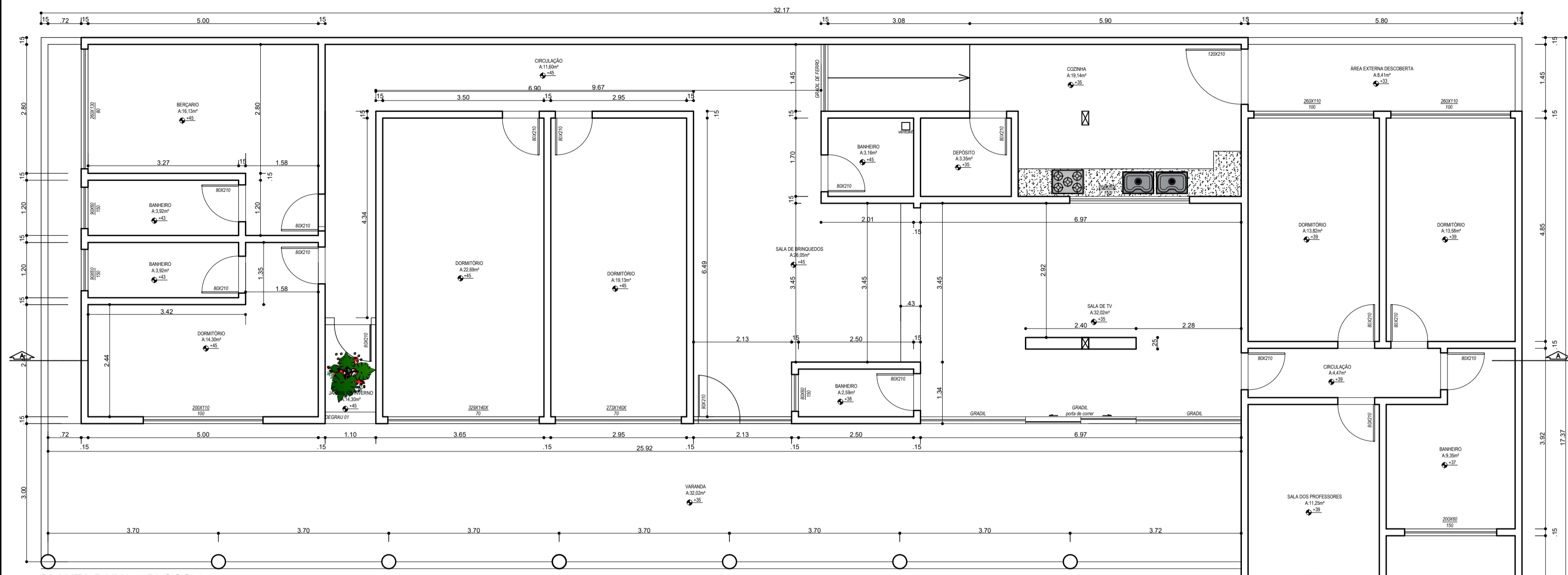

PLANTA BAIXA - BLOCO 1
ESC: 1:50

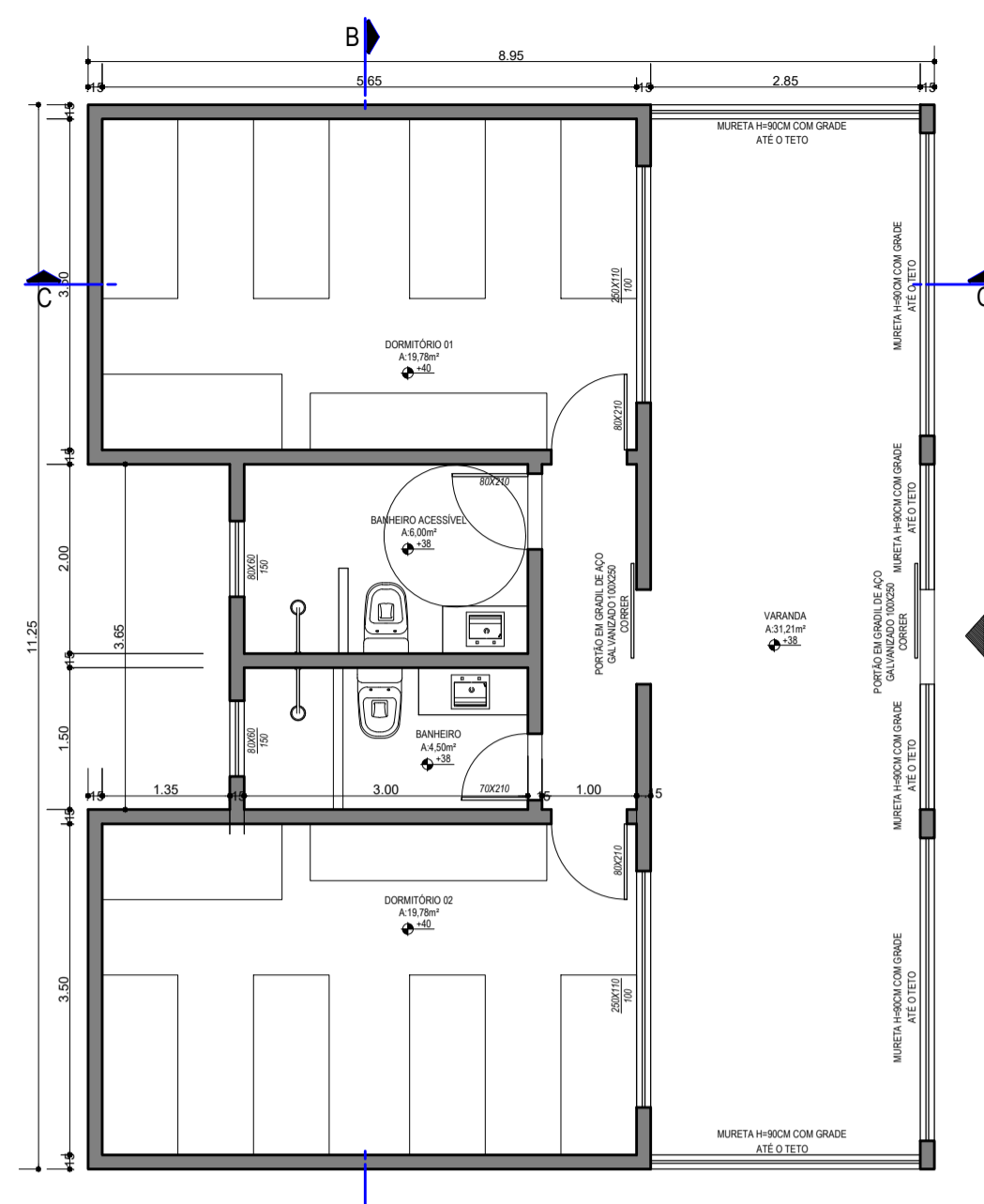

PLANTA BAIXA - BLOCO 4
ESC: 1:50

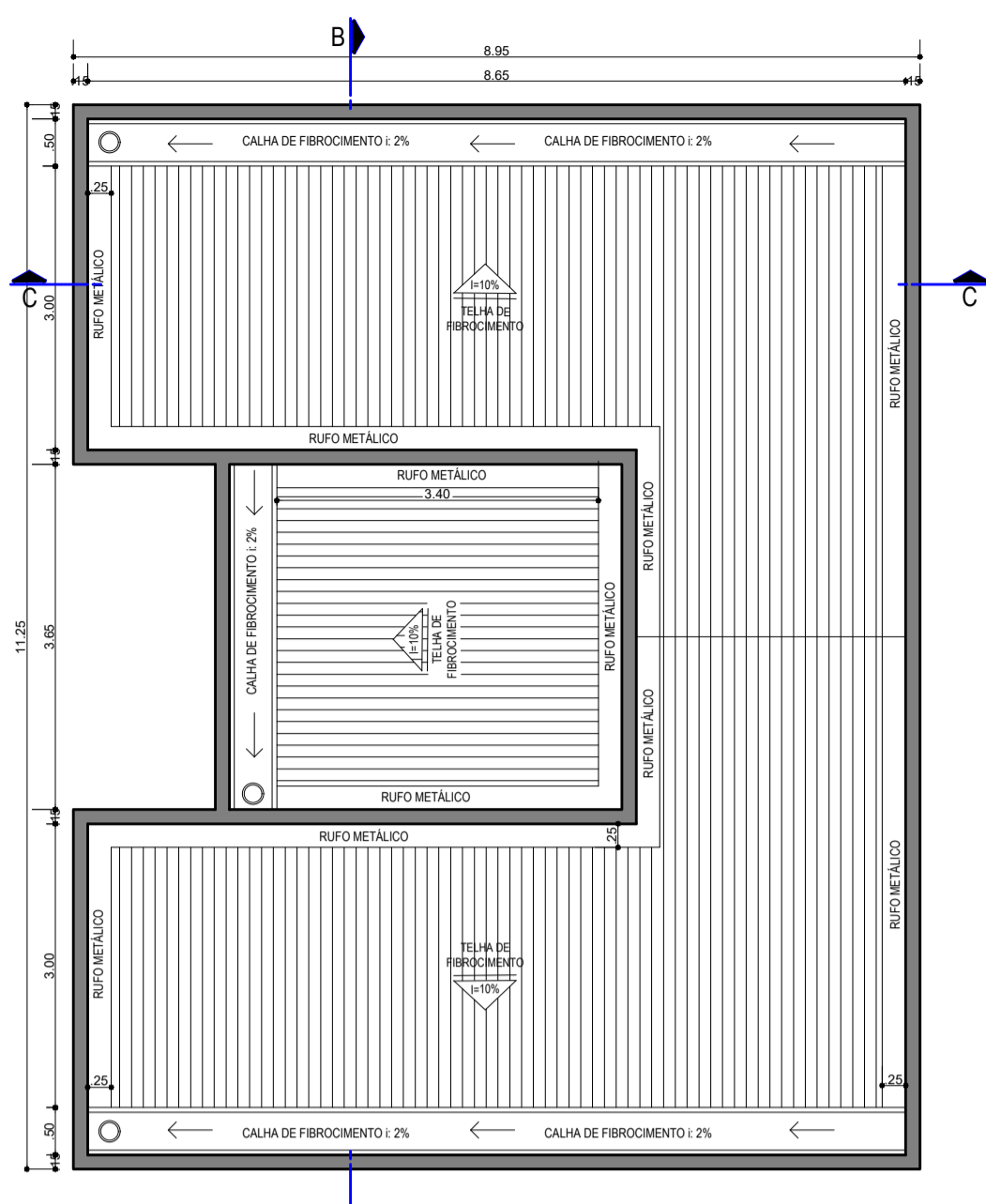

COBERTURA - BLOCO 4
ESC: 1:50

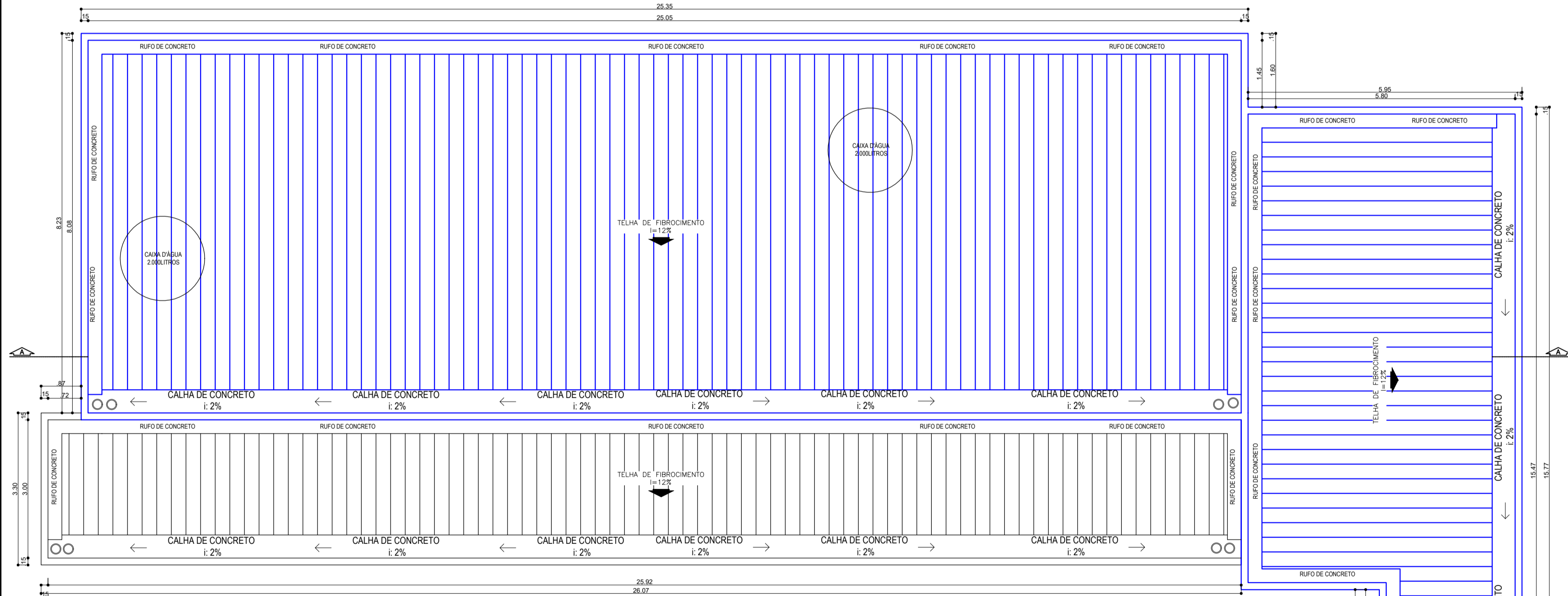

PLANTA DE COBERTURA - BLOCO 1
ESC: 1:50

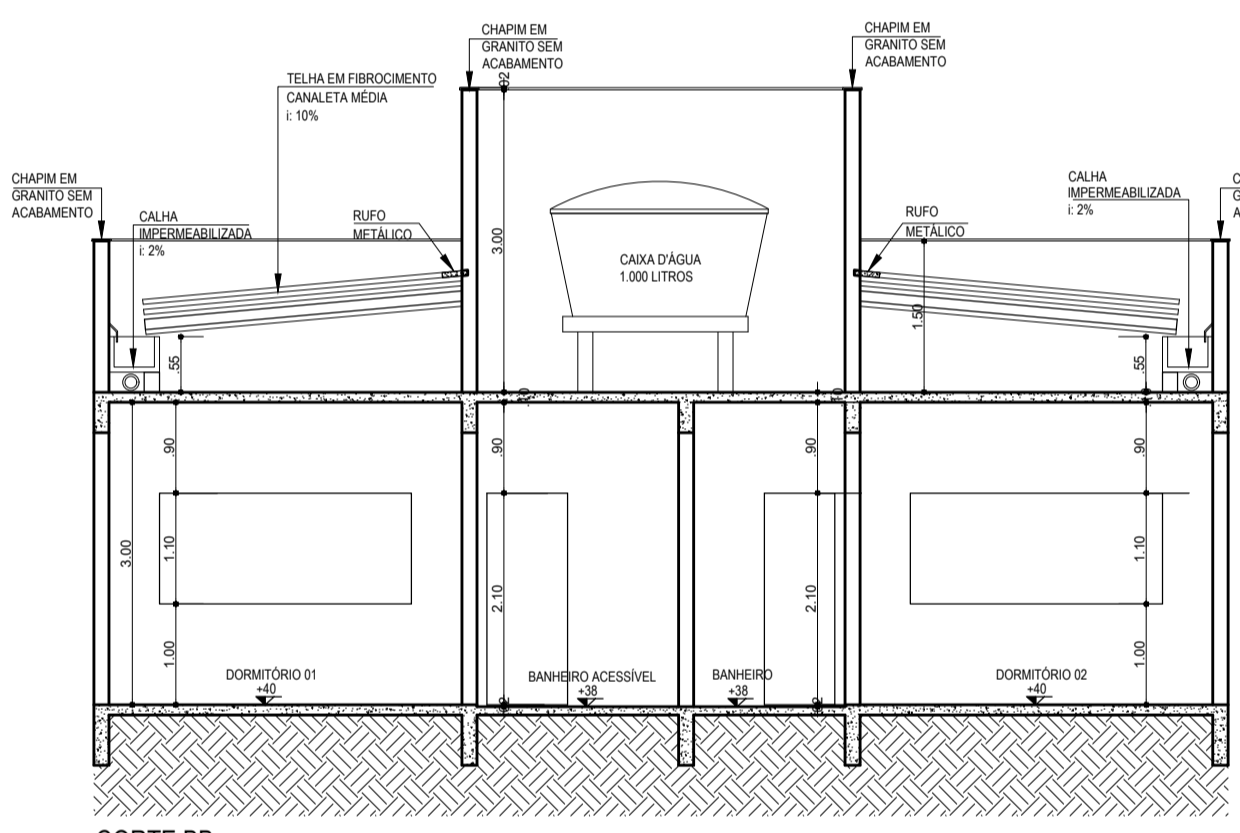

CORTE BB
ESC: 1:50

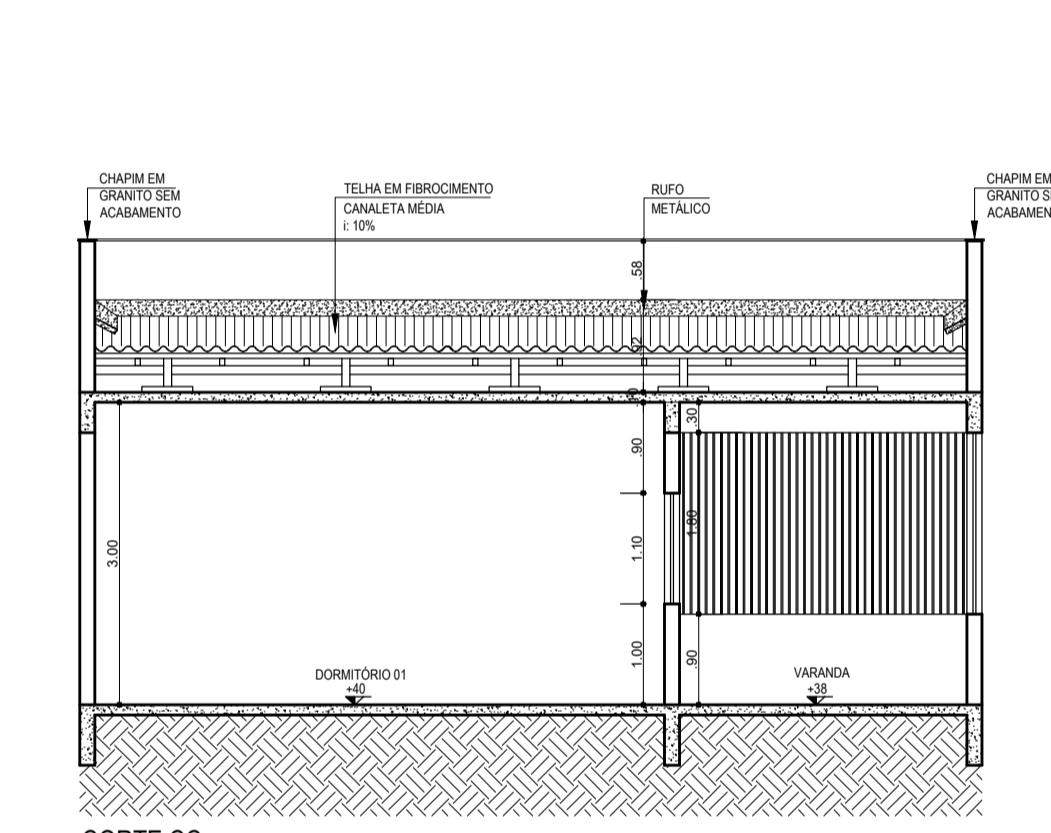

CORTE CC
ESC: 1:50

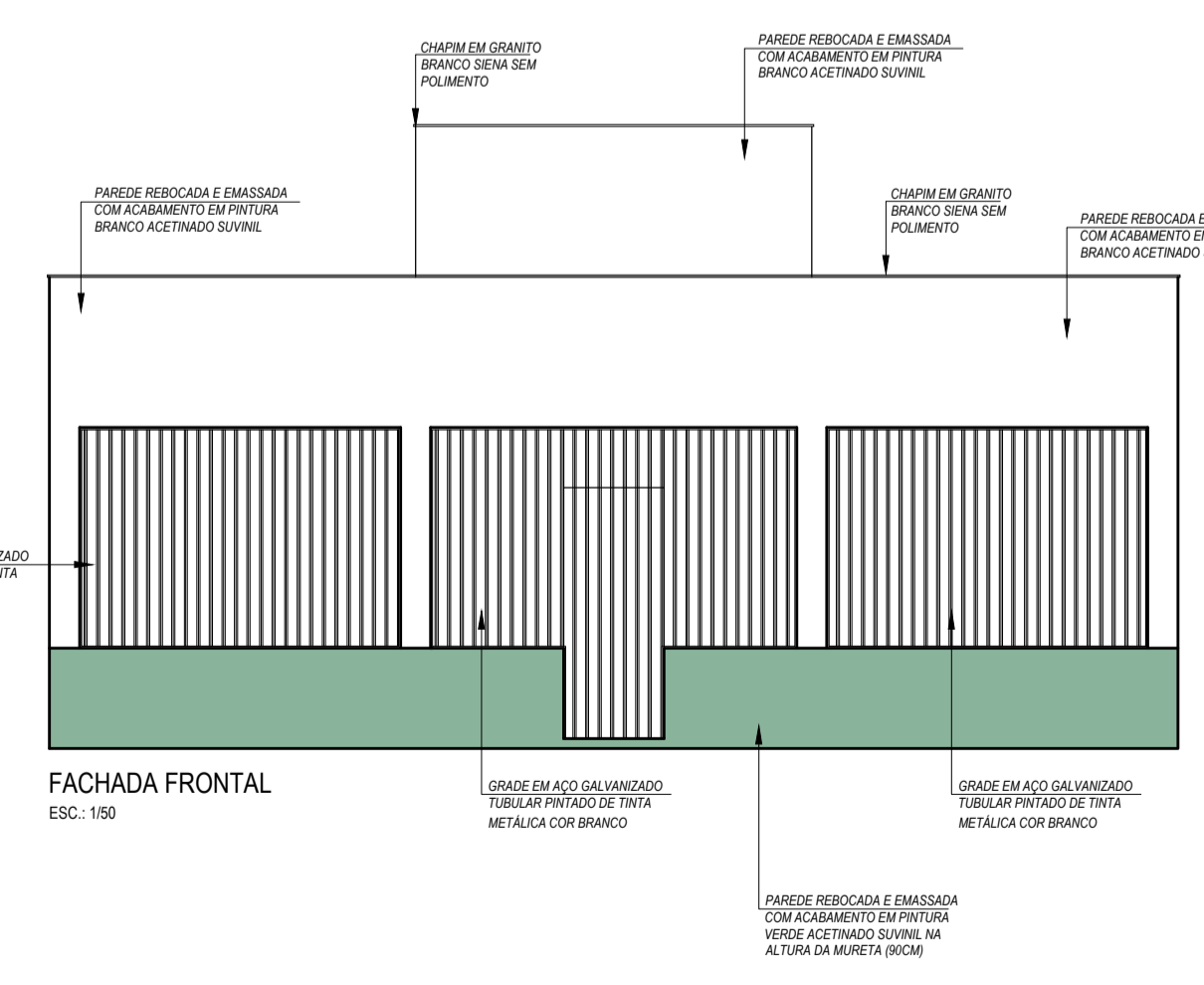

FACHADA FRONTAL
ESC: 1:50

PREFEITURA MUNICIPAL DE SOORETAMA
PROJETO DE REFORMA ABRIGO MUNICIPAL

ENDEREÇO: JISLANIA BOBBIO
Rua: 20.11 (202) 99.1127-030
Verifique em <https://validar.it.gov.br>

DESENHO: JISLANIA BOBBIO

DATA: JULHO/2023

PRANCHA: 04/05

OBS:

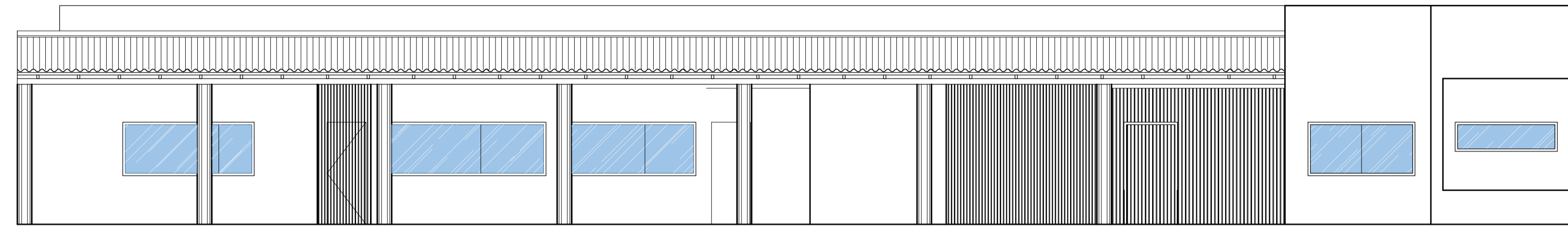

FACHADA FRONTAL - A
ESC: 1/100

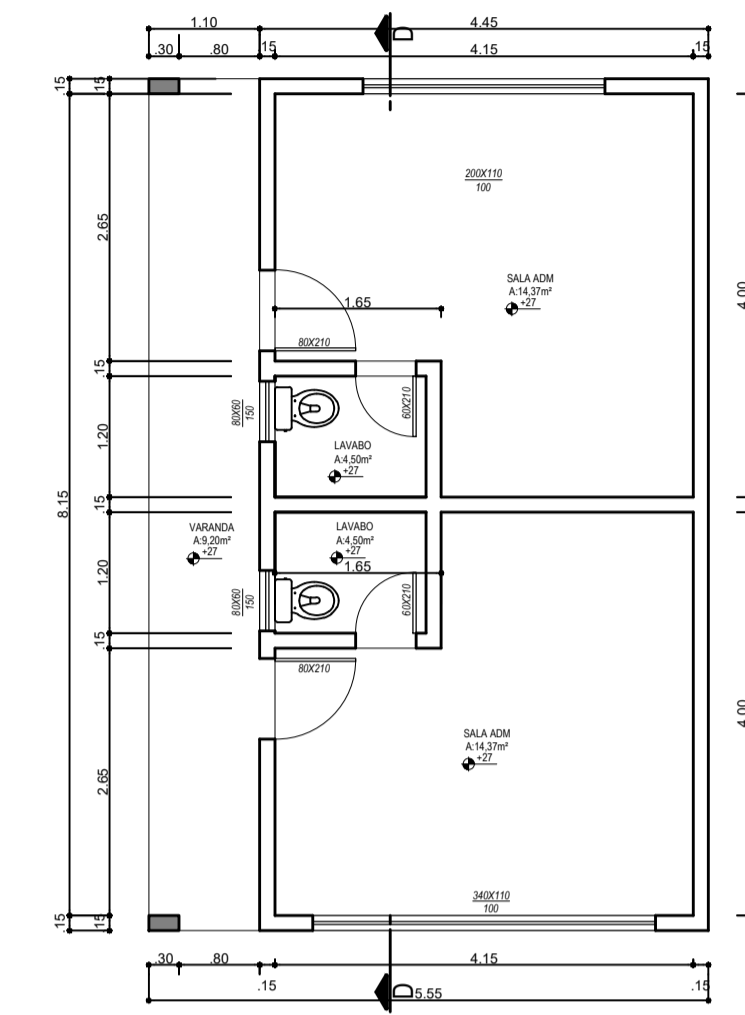

PLANTA BAIXA - BLOCO 2
esc 1:50

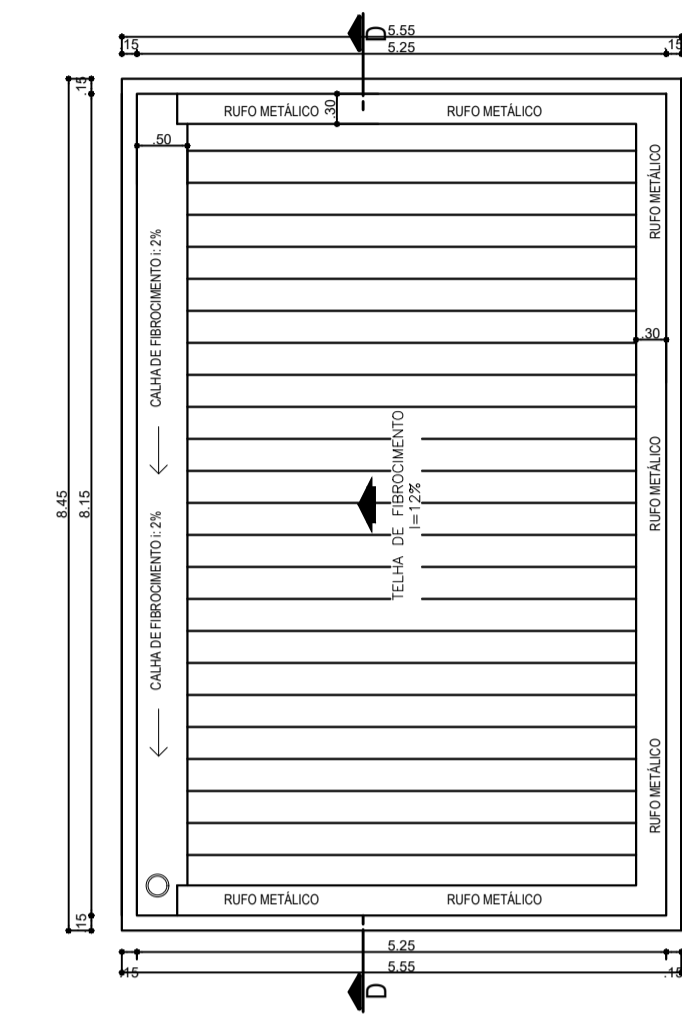

PLANTA BAIXA - BLOCO 2
esc 1:50

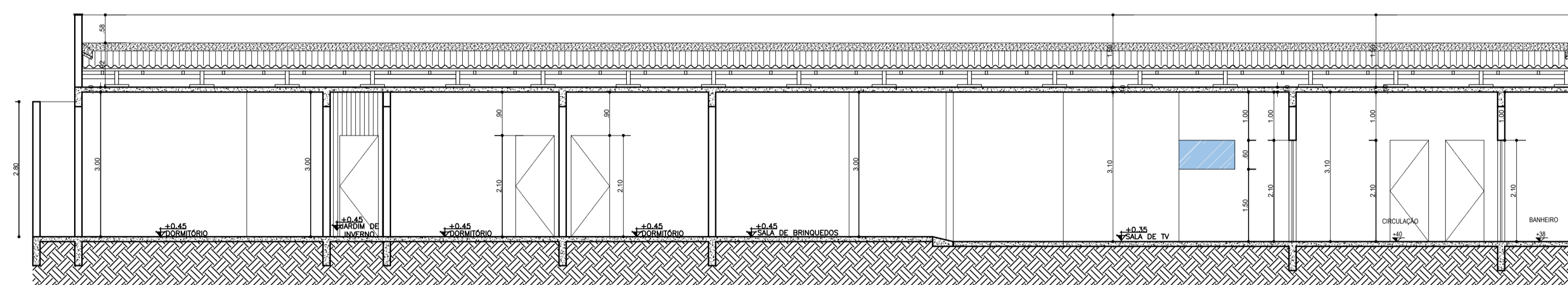

CORTE AA - BLOCO 1
esc 1:50

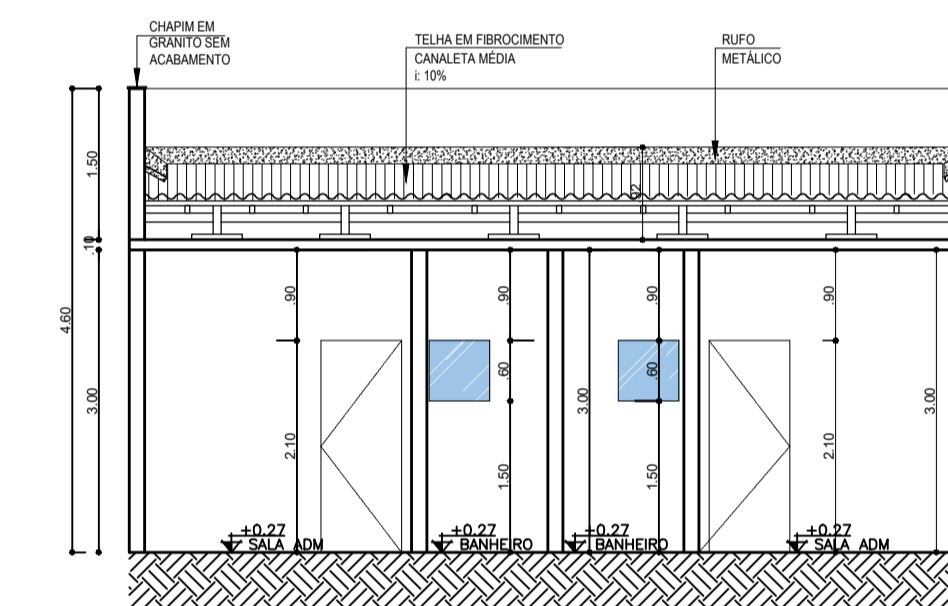

CORTE DD
ESC: 1:50

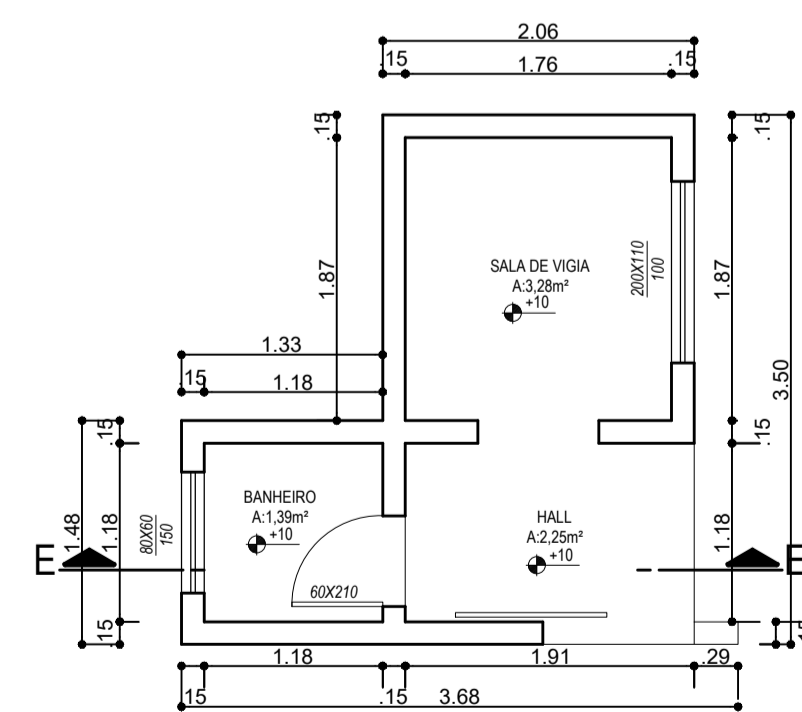

PLANTA BAIXA - BLOCO 3
esc 1:50

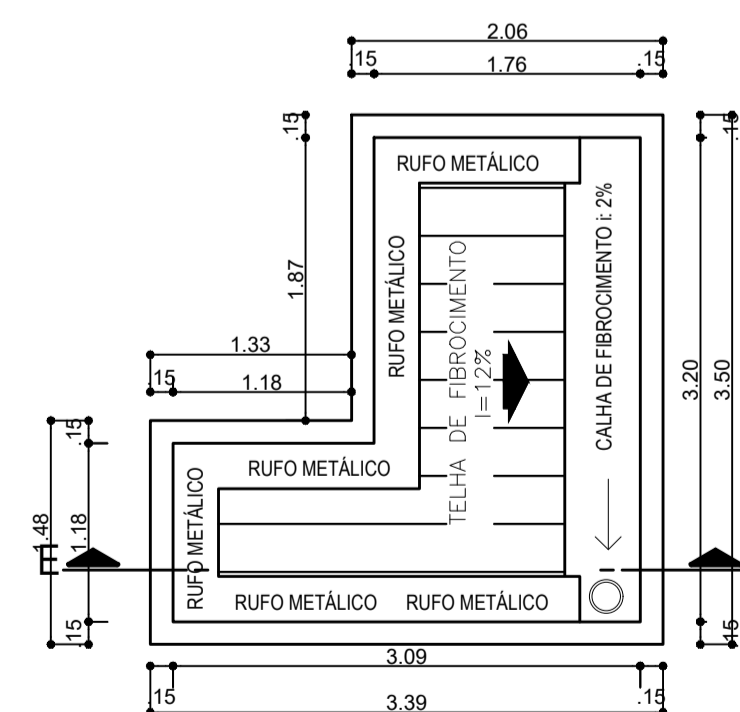

PLANTA BAIXA - BLOCO 3
esc 1:50

